

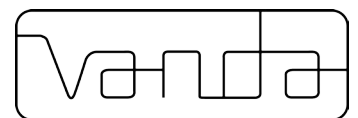

MANUAL EASY
OPERATION TO BEND

FOREST KS[®] *Klick System*

Highly efficient hand drawn system for all types of medium and light weight draperies. Quick installation with "Smart Klick" brackets for wall and ceiling applications.



THE WORLD
BEHIND
YOUR
CURTAINS



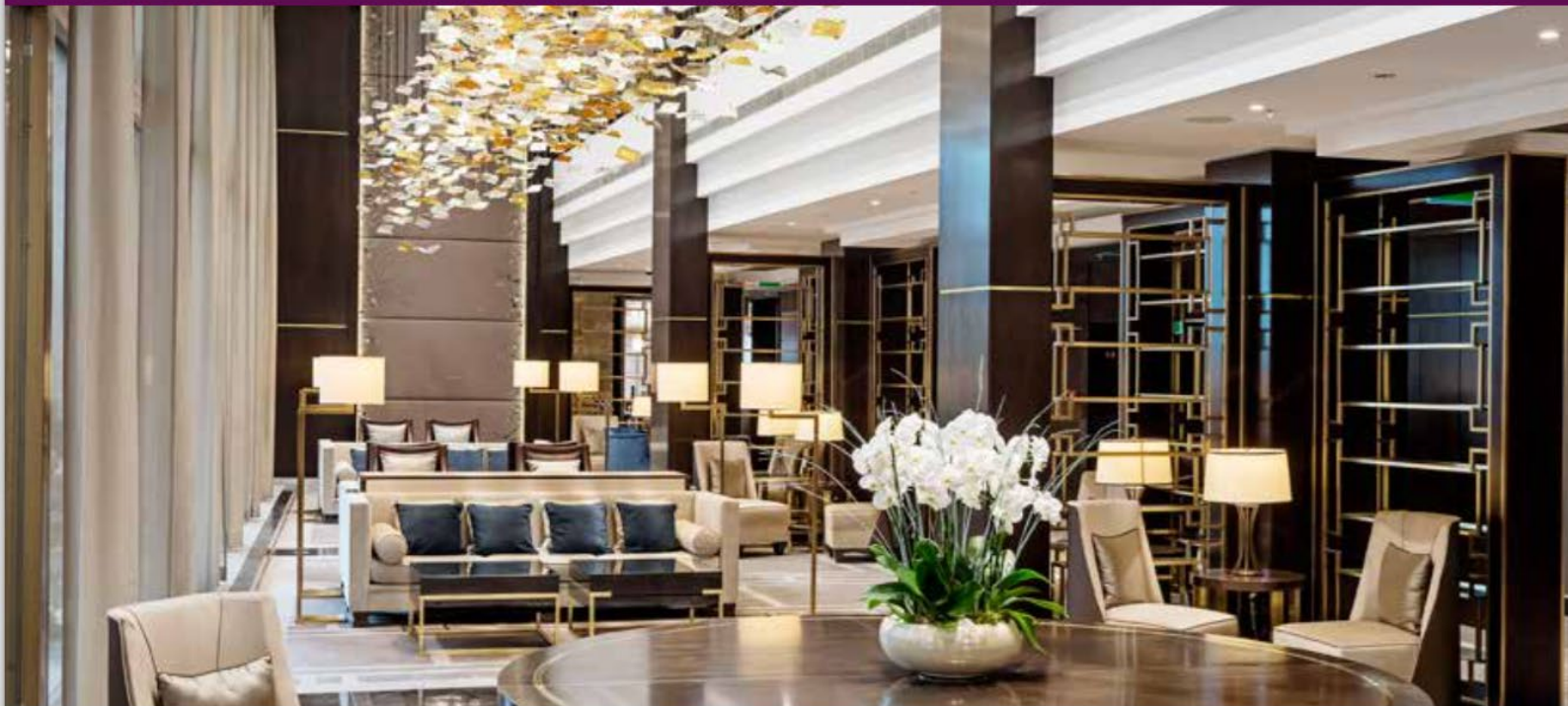

PRODUCT INFORMATION

- Highly efficient hand drawn system for all types of medium weight draperies.
- Quick installation with "Smart Klick" brackets for wall and ceiling applications with cover caps that conceal the screws.
- Bendable; it can be curved and reversed curved
- Bends - 100mm Radius
- Heavy duty clickable carriers, UV-protected, for smooth and easy traversing.
- Offset shape carriers for straight hanging pleats.
- Can be used with standard carriers or Vanda Wave Heading
- Maximum fabric weight: 8 kg per meter
- Colours available: white, silver and black
- Special powdercoat colours: available on request.
- Available in 6m lengths
- Track finish: chromated powder coated with a factory applied patented dry lubricant.

PROFILE

- Shown actual size 1:1.
- Aluminium Extrusion.
- Weight: 150 grams per meter
- Dimensions: 14 mm x 20 mm

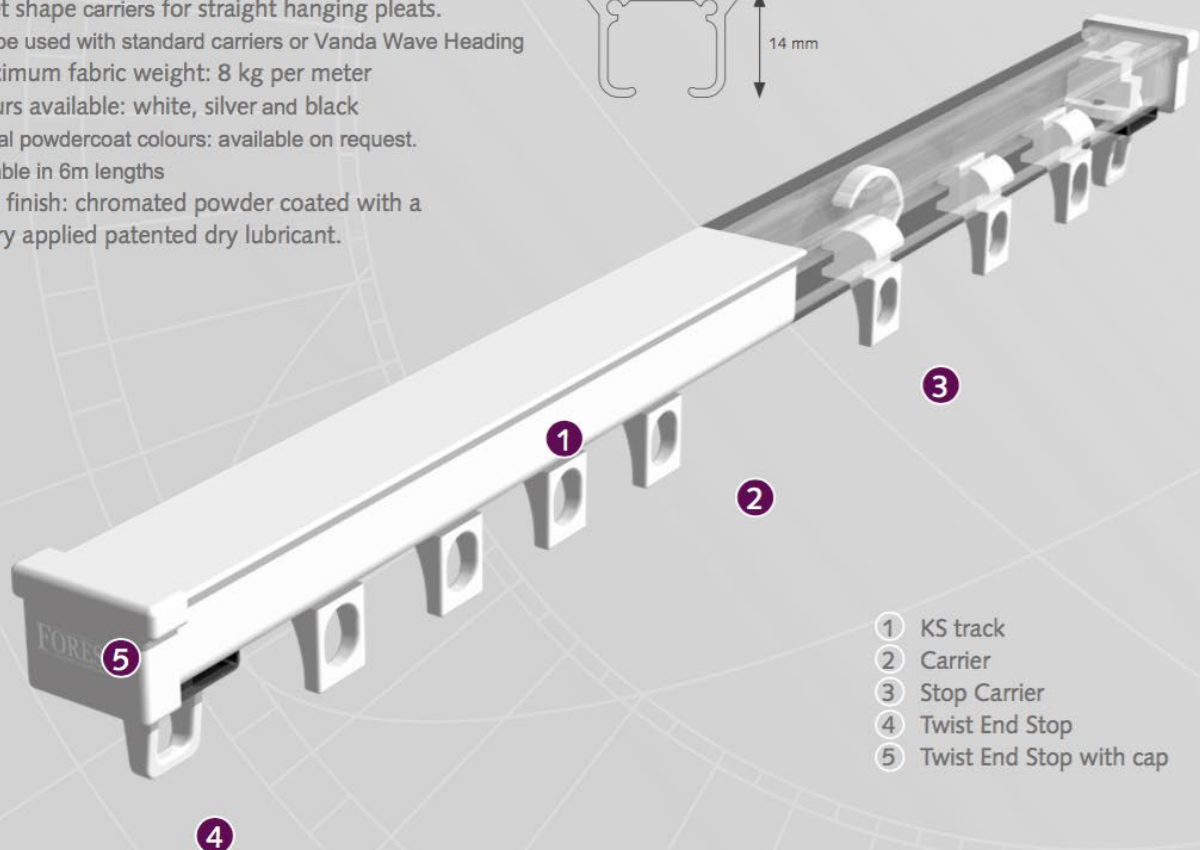
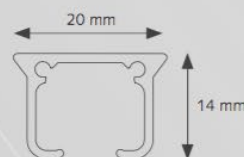

- 1 KS track
- 2 Carrier
- 3 Stop Carrier
- 4 Twist End Stop
- 5 Twist End Stop with cap



FOR USE IN

Hotels - offices - schools - healthcare - residences - boats - campers - planes or at any location where an efficient hand drawn system is required.



Easy installation
click - position - tighten

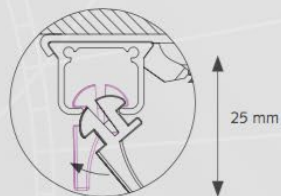

clickable carrier

BENDING / CURVING

The track can be curved and reversed curved using a 100mm radius. Additionally there is a curving possibility, please enquiry for further information.

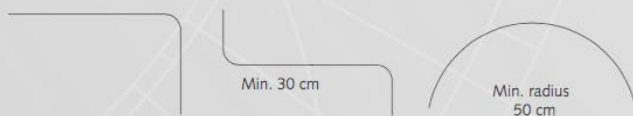

SPECIAL WINDOW DECORATION

Special bends

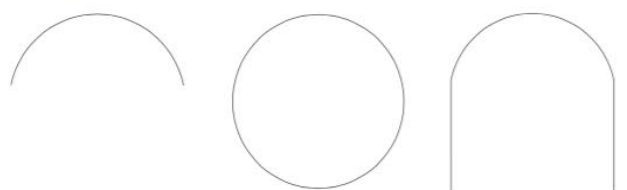

APPLICATIONS

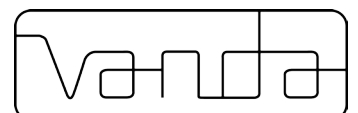
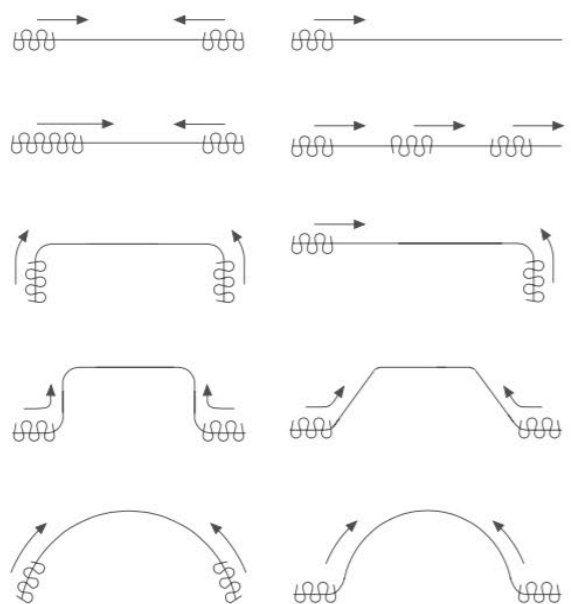

MOUNTING BRACKETS

Wall bracket

3.5 cm
6 cm

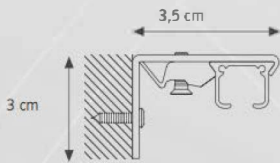

A) Min. 10 cm

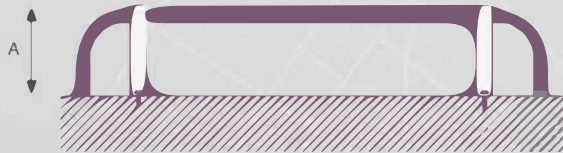

A) Min. 16 cm

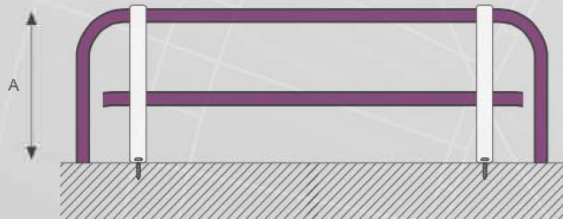

Spring Clip Top Fix Bracket

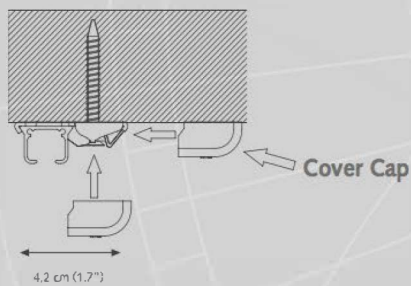

Smart Click Top Fix Bracket



Aluminium Wall bracket single

A) 7.5 B) 6.3 cm

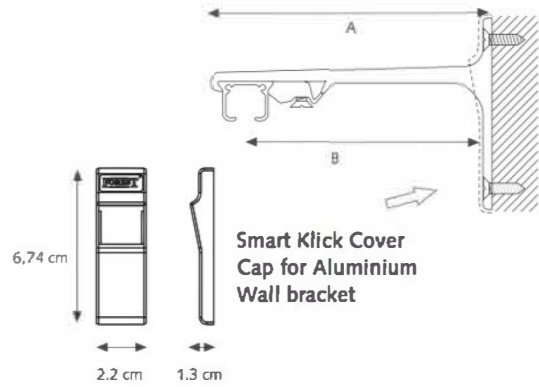

Aluminium Wall bracket double

A) 15 cm B) 9.2 cm C) 4.5 cm

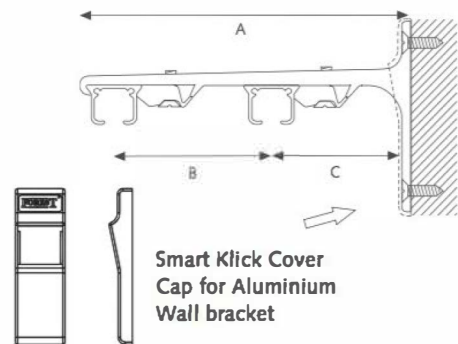

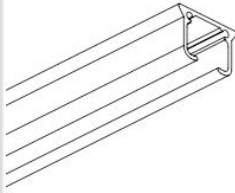

KS TRACK
Aluminium extrusion, powder coated, lubricated.



KS AS CARRIER
"Klickable", offset, constructed of UV-resistant plastic.
14 carriers per meter supplied



KS STOPCARRIER
Prevents slide back, "klickable", constructed of UV-resistant plastic.



SMART CLICK TOP FIX BRACKET
Slides onto the track, powder coated. Regular duty.



SPRING CLIP TOP FIX BRACKET
"Klicks" onto track, powder coated.

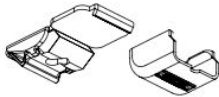

SPRING CLIP TOP FIX BRACKET WITH COVER PLATE



KS SMART KLICK WALL BRACKET 3,5 cm
"Klicks" onto track, powder coated.
One screw attachment. For light weight use only.



KS ADJUSTABLE WALL BRACKET, SINGLE
For light weight use only

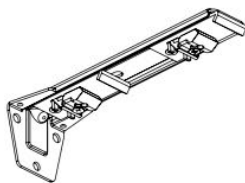

KS ADJUSTABLE WALL BRACKET, DOUBLE
For light weight use only



KS SLIMLINE SINGLE BRACKET

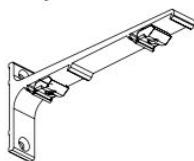

KS SLIMLINE DOUBLE BRACKET



COVER CAP FOR KS SMART KLICK ALUMINIUM WALL BRACKET

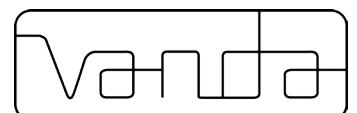

0800 826 326
Enquiries@vanda.co.nz